

CXK5B81020J/TM -12

131072-word × 8-bit High Speed Bi-CMOS Static RAM

Description

CXK5B81020J/TM is a high speed 1M bit Bi-CMOS static RAM organized as 131072 words by 8 bits. Operating on a single 3.3V supply this asynchronous IC is suitable for use in high speed and low power applications.

Features

- Single 3.3V power supply: 3.3V ± 0.3V
- Fast access time 12ns (Max.)
- Low standby current: 10mA (Max.)
- Low power operation 864mW (Max.)
- Package line-up
 Dual Vcc/Vss
 CXK5B81020J 400mil 32pin SOJ package
 CXK5B81020TM 400mil 32pin TSOP package

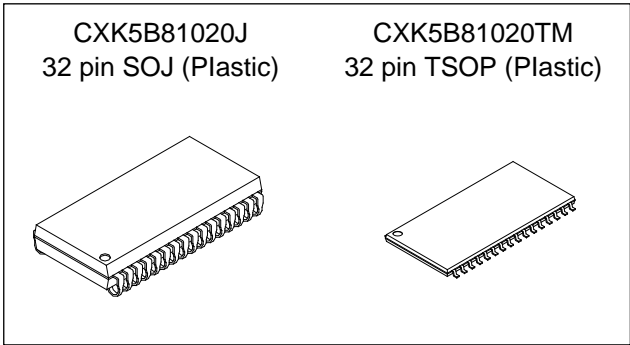

Function

131072 word × 8-bit static RAM

Structure

Silicon gate Bi-CMOS IC

Block Diagram

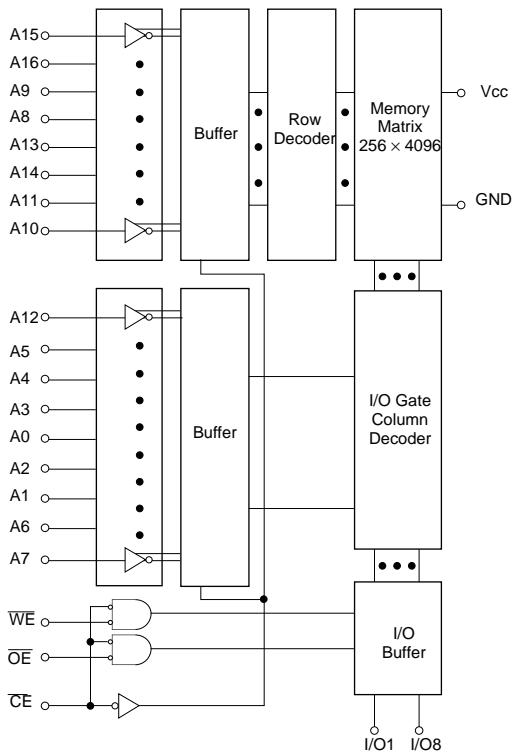

Pin Configuration (Top View) Pin Description

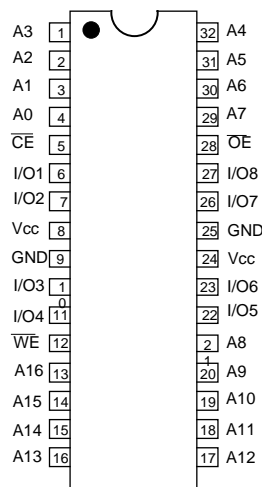

Symbol	Description
A0 to A16	Address input
I/O1 to I/O8	Data input
\overline{CE}	Chip enable input
\overline{WE}	Write enable input
\overline{OE}	Output enable input
Vcc	+3.3V power supply
GND	Ground
NC	No connection

Sony reserves the right to change products and specifications without prior notice. This information does not convey any license by any implication or otherwise under any patents or other right. Application circuits shown, if any, are typical examples illustrating the operation of the devices. Sony cannot assume responsibility for any problems arising out of the use of these circuits.

Absolute Maximum Ratings

(Ta = 25°C, GND = 0V)

Item	Symbol	Rating	Unit	
Supply voltage	V _{CC}	-0.5*1 to +4.6	V	
Input voltage	V _{IN}	-0.5*1 to V _{CC} + 0.5	V	
Input and output voltage	V _{I/O}	-0.5*1 to V _{CC} + 0.5	V	
Allowable power dissipation	P _D	1.5*2	W	
Operating temperature	T _{opr}	0 to +70	°C	
Storage temperature	T _{stg}	-55 to +150	°C	
Soldering temperature • time	T _{solder}	J	260 • 10	°C • sec
		TM	235 • 10	°C • sec

*1 V_{CC}, V_{IN}, V_{I/O} = -2.0V Min. for pulse width less than 5ns.

*2 Air flow ≥ 1m/s.

Truth Table

\overline{CE}	\overline{OE}	\overline{WE}	Mode	I/O1 to I/O8	Current
H	×	×	Not selected	High Z	I _{SB1} , I _{SB2}
L	L	H	Read	Data out	I _{CC}
L	×	L	Write	Data in	I _{CC}
L	H	H	Output disable	High Z	I _{CC}

×: "H" or "L"

Recommended Operating Conditions

(Ta = 0 to +70°C, GND = 0V)

Item	Symbol	Min.	Typ.	Max.	Unit
Supply voltage	V _{CC}	3.0	3.3	3.6	V
Input high voltage	V _{IH}	2.0	—	V _{CC} + 0.3	V
Input low voltage	V _{IL}	-0.3*	—	0.8	V

* V_{IL} = -2.0V Min. for pulse width less than 5ns.

Electrical Characteristics

DC Characteristics

($V_{CC} = 3.3V \pm 0.3V$, $GND = 0V$, $T_a = 0$ to $+70^\circ C$)

Item	Symbol	Conditions	Min.	Typ.*	Max	Unit
Input leakage current	I_{LI}	$V_{IN} = GND$ to V_{CC}	-10	—	+10	μA
Output leakage current	I_{LO}	$\overline{CE} = V_{IH}$ or $\overline{OE} = V_{IH}$ or $\overline{WE} = V_{IL}$ $V_{I/O} = GND$ to V_{CC}	-10	—	+10	μA
Average operating current	I_{CC}	Cycle: Min. Duty = 100% $I_{OUT} = 0mA$ $\overline{CE} = V_{IL}$ $V_{IN} = V_{IH}$ or V_{IL}	—	—	240	mA
Standby current	I_{SB1}	$\overline{CE} \geq V_{CC} - 0.2V$ $V_{IN} \geq V_{CC} - 0.2V$ or $V_{IN} \leq 0.2V$	—	—	10	mA
	I_{SB2}	Cycle: Min. Duty = 100% $\overline{CE} = V_{IH}$ $V_{IN} = V_{IH}$ or V_{IL}	—	—	100	mA
Output high voltage	V_{OH}	$I_{OH} = -2.0mA$	2.4	—	—	V
Output low voltage	V_{OL}	$I_{OL} = 2.0mA$	—	—	0.4	V

* $V_{CC} = 3.3V$, $T_a = 25^\circ C$

I/O Capacitance

($T_a = 25^\circ C$, $f = 1MHz$)

Item	Symbol	Conditions	Min.	Typ.	Max	Unit
Input capacitance	C_{IN}	$V_{IN} = 0V$	—	—	5	pF
I/O capacitance	$C_{I/O}$	$V_{I/O} = 0V$	—	—	7	pF

Note) This parameter is sampled and is not 100% tested.

AC Characteristics

• **AC test condition** ($V_{CC} = 3.3V \pm 0.3V$, $T_a = 0$ to $+75^\circ C$)

Item	Condition
Input pulse high level	$V_{IH} = 3.0V$
Input pulse low level	$V_{IL} = 0.0V$
Input rise time	$t_r = 2ns$
Input fall time	$t_f = 2ns$
Input and output reference level	1.4V
Output load conditions	Fig. 1

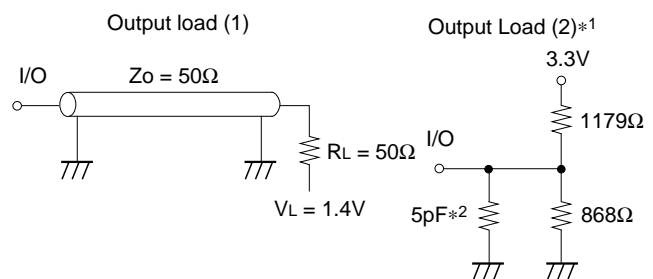

*1. t_{LZ} , t_{OLZ} , t_{HZ} , t_{OHZ} , t_{OW} , t_{WHZ}

*2. Including scope and jig capacitances

Fig. 1

• Read cycle

Item	Symbol	-12		Unit
		Min.	Max.	
Read cycle time	t _{RC}	12	—	ns
Address access time	t _{AA}	—	12	ns
Chip enable access time	t _{CO}	—	12	ns
Output enable to output valid	t _{OE}	—	6	ns
Output data hold time	t _{OH}	3	—	ns
Chip enable to output in low Z (\overline{CE})	t _{LZ}	3	—	ns
Output enable to output in low Z (\overline{OE})	t _{OLZ} *	0	—	ns
Chip disable to output in high Z (\overline{CE})	t _{HZ} *	0	6	ns
Output disable to output in high Z (\overline{OE})	t _{OHZ} *	0	6	ns

* Transition is measured $\pm 200\text{mV}$ from steady voltage with specified loading in Fig. 1 1-(2).
This parameter is sampled and is not 100% tested.

• Write cycle

Item	Symbol	-12		Unit
		Min.	Max.	
Write cycle time	t _{WC}	12	—	ns
Address valid to end of write	t _{AW}	10	—	ns
Chip enable to end of write	t _{CW}	10	—	ns
Data valid to end of write	t _{DW}	8	—	ns
Data hold from end of write	t _{DH}	0	—	ns
Write pulse width	t _{WP}	10	—	ns
Address set up time	t _{AS}	0	—	ns
Write recovery time	t _{WR}	0	—	ns
Output active from end of write	t _{OW} *	4	—	ns
Write to output in high Z	t _{WHZ} *	0	6	ns

* Transition is measured $\pm 200\text{mV}$ from steady voltage with specified loading in Fig. 1 1-(2).
This parameter is sampled and is not 100% tested.

Timing Waveform

- Read cycle (1) : $\overline{OE}=V_{IL}, \overline{WE}=V_{IH}$

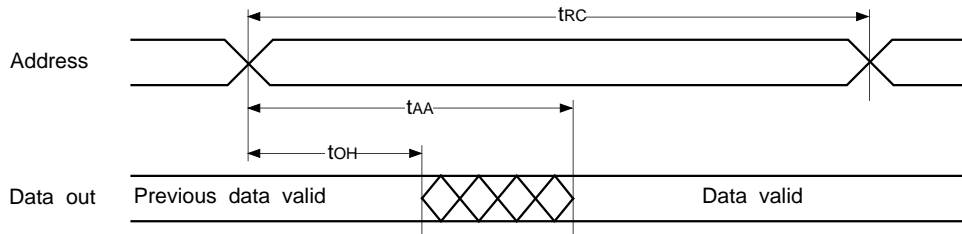

- Read cycle (2) : $\overline{WE}=V_{IH}$

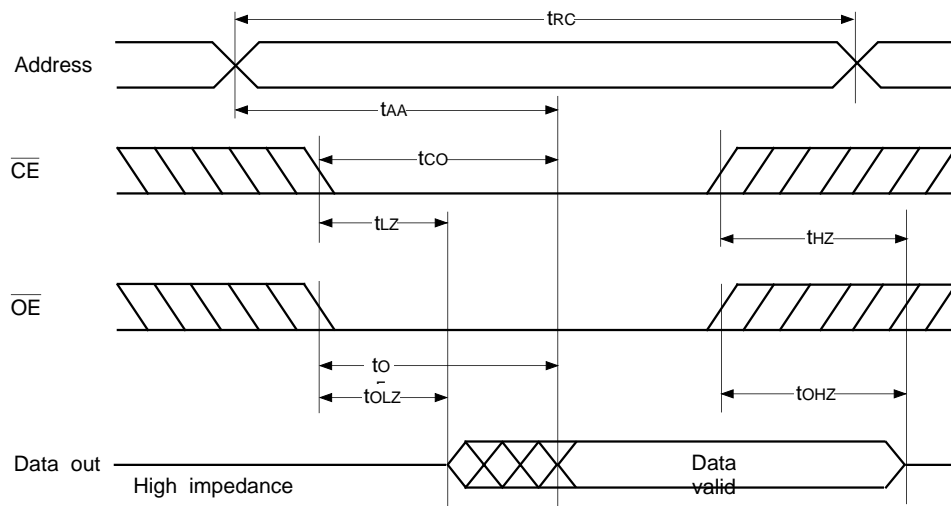

• Write cycle (1) : \overline{WE} control

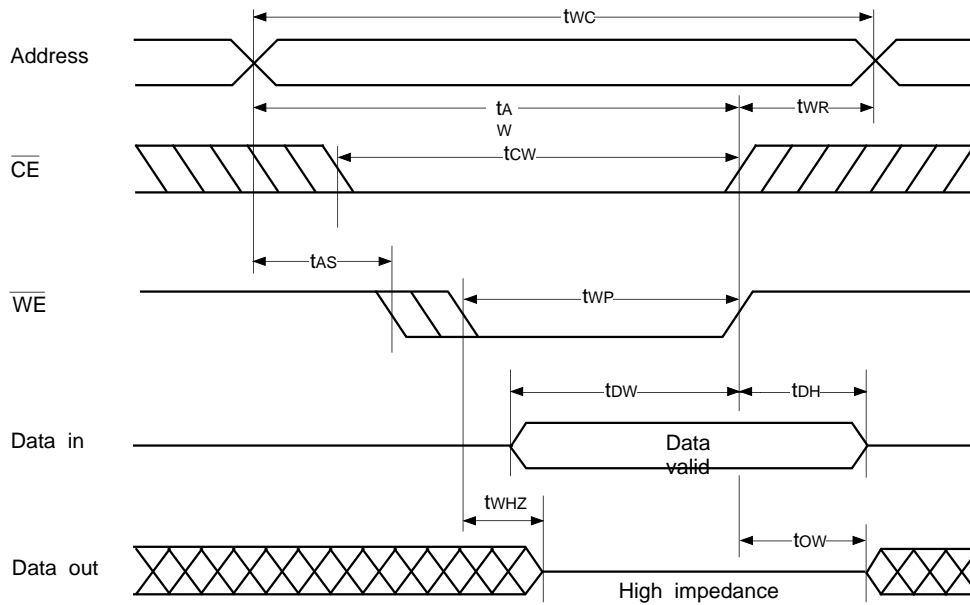

• Write cycle (2) : \overline{CE} control

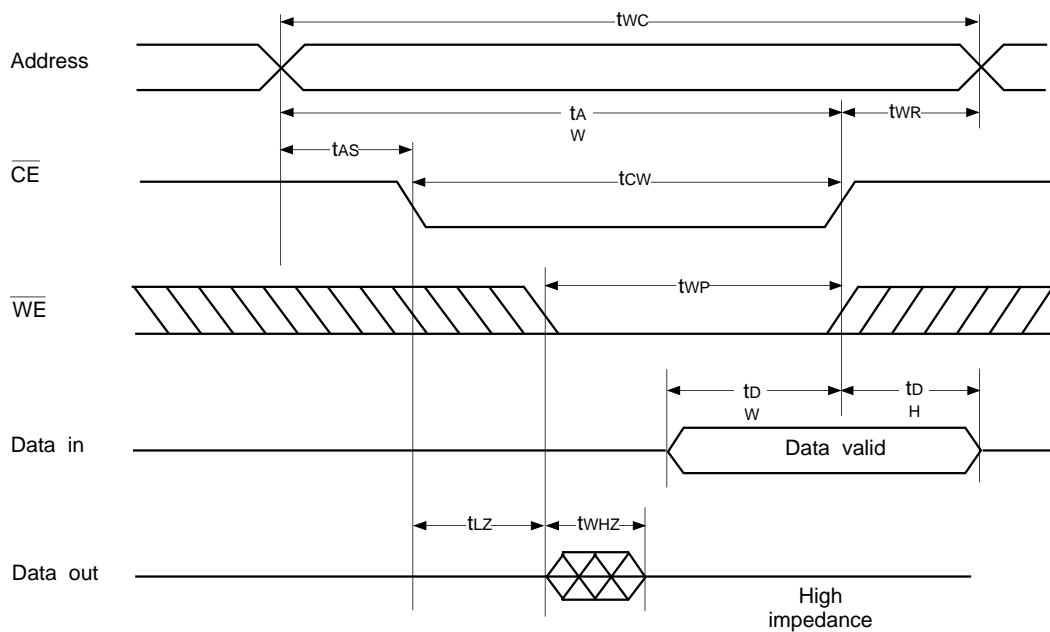

* Do not apply the data input voltage of the opposite phase to the output while I/O pin is in output condition.

Example of Representative Characteristics

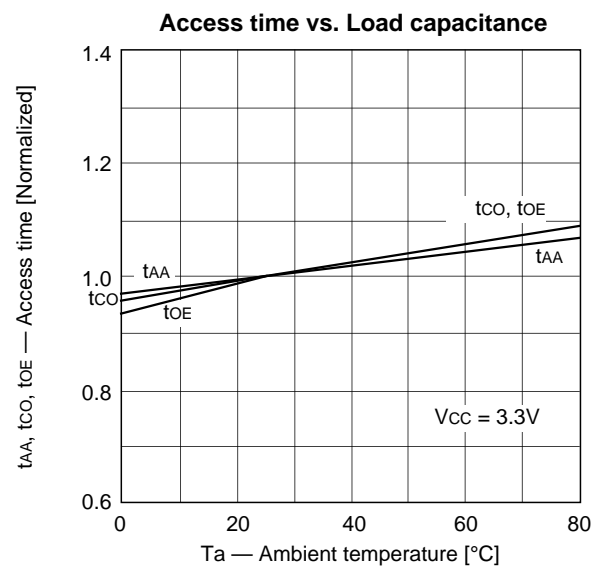
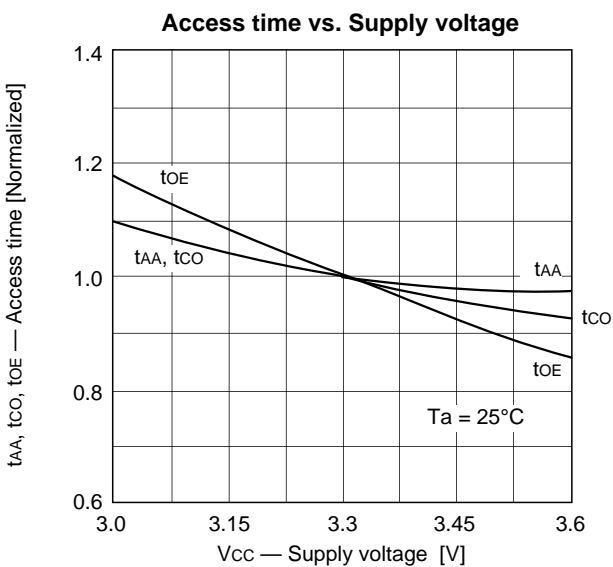
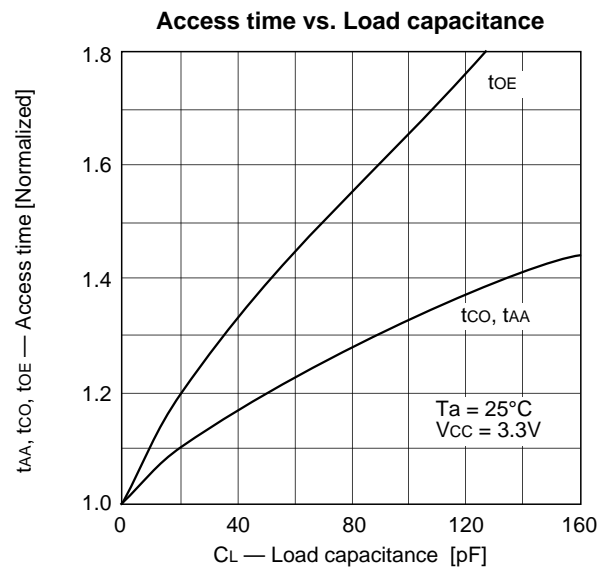
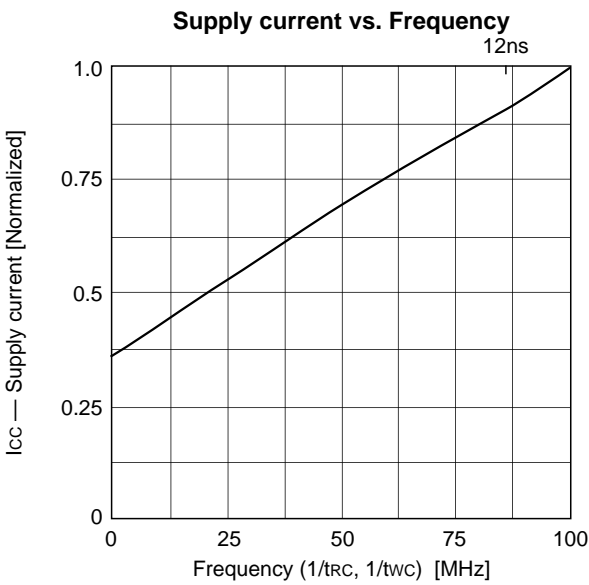
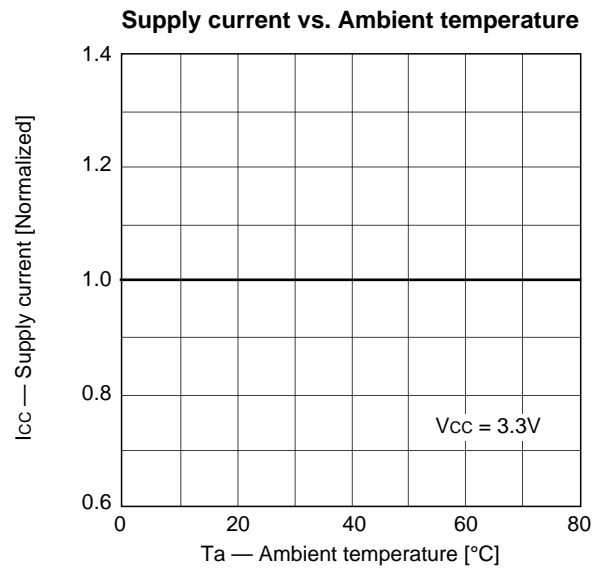
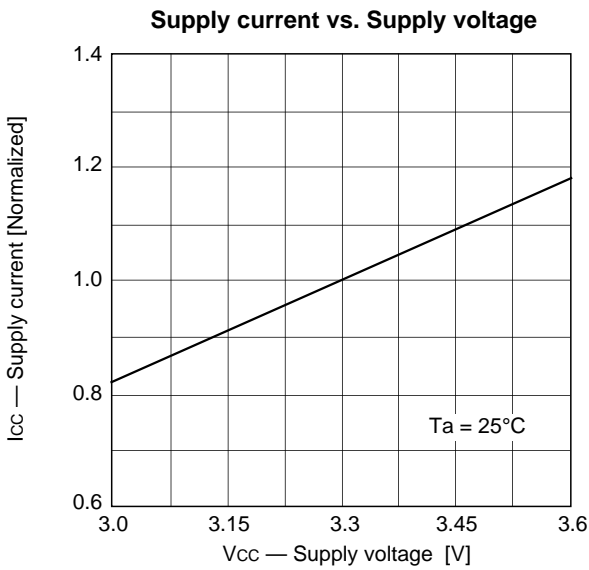

Standby current vs. Supply voltage

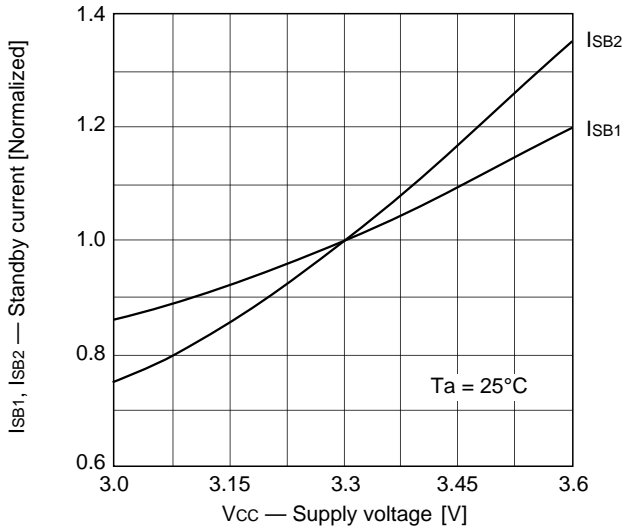

Standby current vs. Ambient temperature

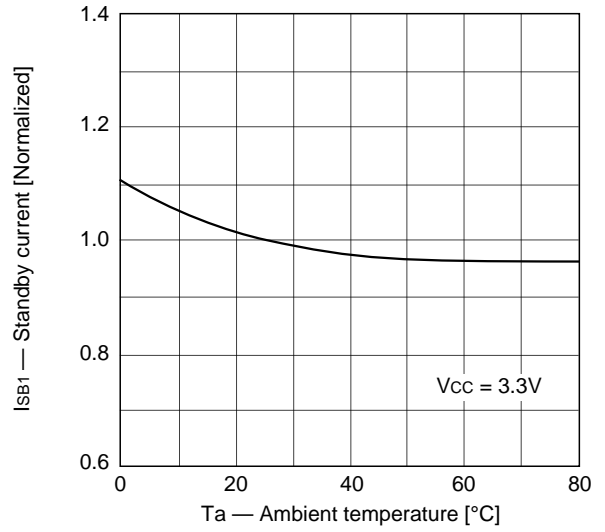

Input voltage level vs. Supply voltage

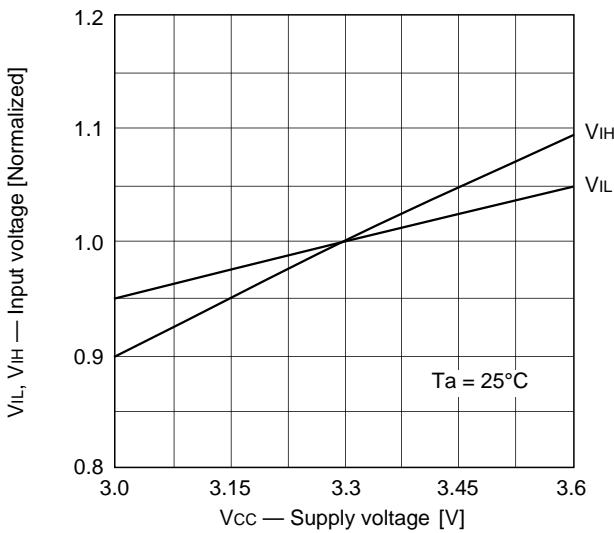

Standby current vs. Ambient temperature

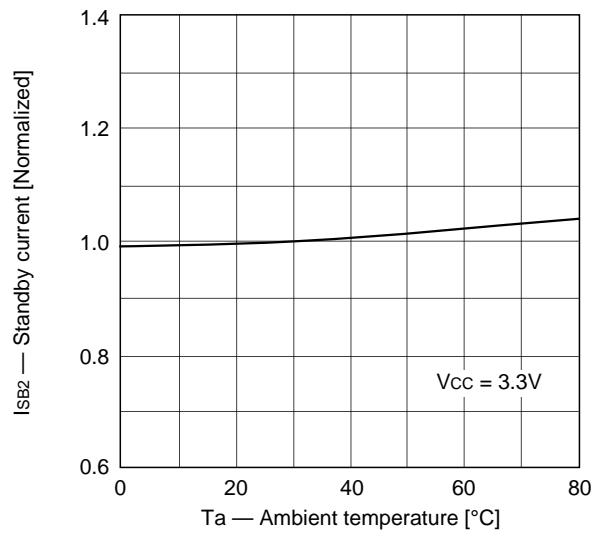

Output high current vs. Output high voltage

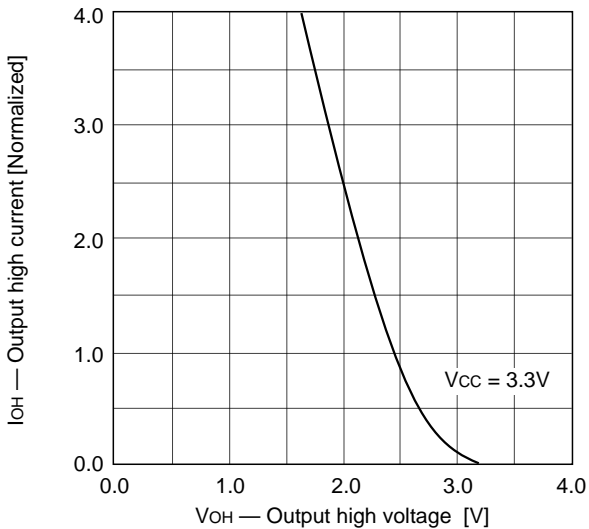

Output low current vs. Output low voltage

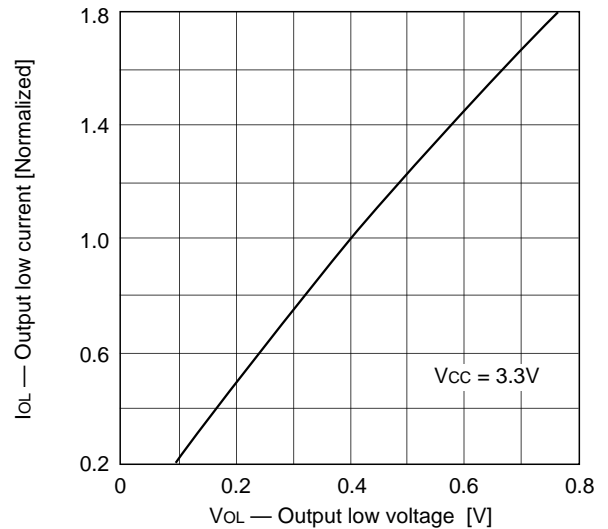

Package Outline Unit: mm

CXK5B81020J

32PIN SOJ (PLASTIC) 400mil

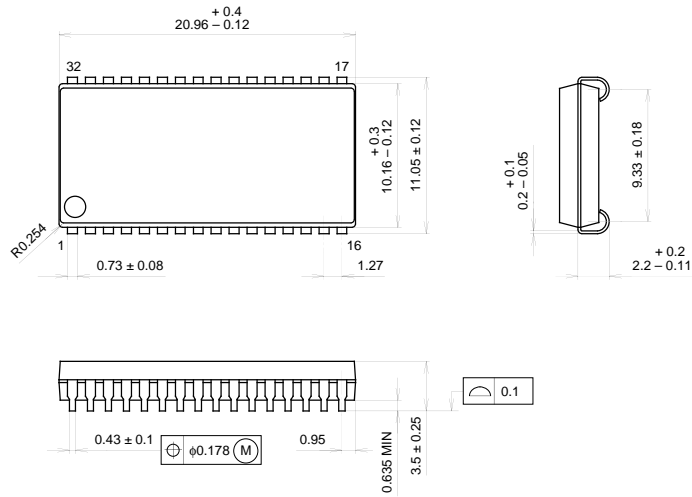

PACKAGE STRUCTURE

SONY CODE	SOJ-32P-01	PACKAGE MATERIAL	EPOXY RESIN
EIAJ CODE	*SOJ032-P-0400-A	LEAD TREATMENT	SOLDER PLATING
JEDEC CODE		LEAD MATERIAL	42 / COPPER ALLOY
		PACKAGE WEIGHT	1.3g

CXK5B81020TM

32PIN TSOP (II) (PLASTIC) 400mil

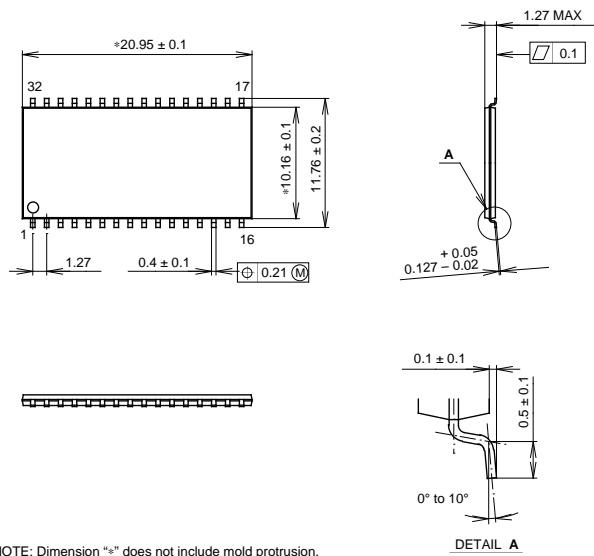

PACKAGE STRUCTURE

SONY CODE	TSOP (II) -32P-L01	PACKAGE MATERIAL	EPOXY / PHENOL RESIN
EIAJ CODE	TSOP (II) 032-P-0400-A	LEAD TREATMENT	SOLDER PLATING
JEDEC CODE		LEAD MATERIAL	42 ALLOY
		PACKAGE WEIGHT	